

THE PROPERTY OF THE DRAWING IS ESTABLISHED BY LAW. IT IS FORBIDDEN TO PRODUCE OR SHOW IT TO THIRD PART. WITHOUT A WRITTEN AGREEMENT.

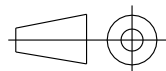
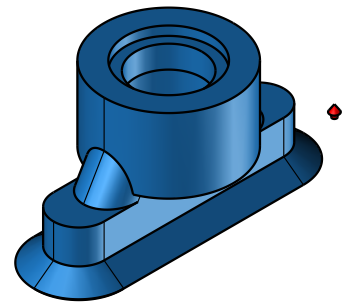
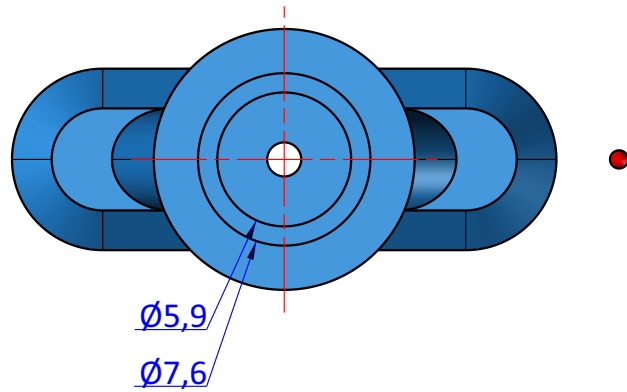
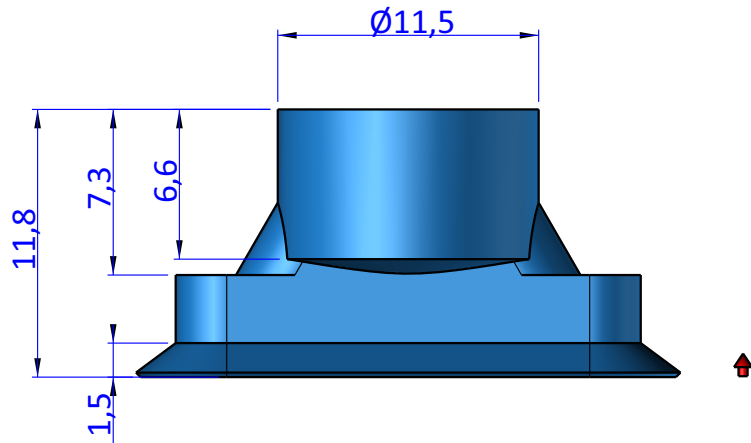
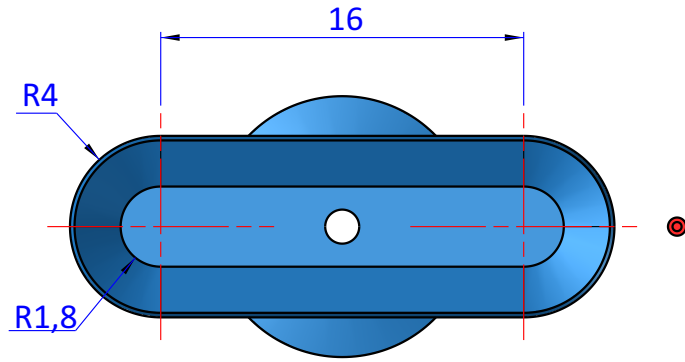

DESIGNED FROM	REVIEW
FPS Automation	A

DATE	WEIGHT
06/10/2020	0,001kg

CODE
CA.08.39.004

Format A4

UNI 936-76

GENERAL TOLERANCE

UNI - ISO 2768

CLASSE f

DESCRIPTION

CA.08.39.004